

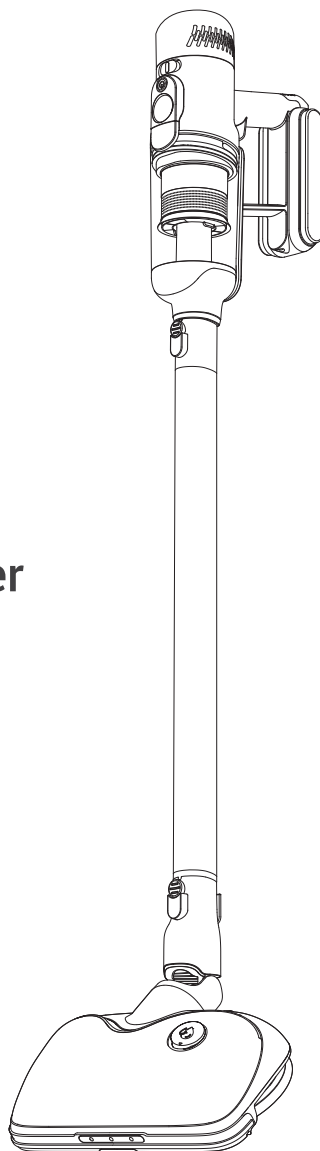

T12 Series

Operating Manual Mopping Vacuum Cleaner



The operation manual is a general user guideline for the T12 series. T12 series includes T12 Plus Rinse, T12 Storm Rinse, T12 Pro Rinse, etc. The brush configuration varies with each model. For the specific configuration for the model you purchased, the packing list shall prevail.

Contents:

I. Safety Instructions	1
II. Product Introduction and Operation Instructions	3
1. Vacuum Main Body	3
2. Accessories	5
2.1-2.12 Detailed Configuration Instructions	5
2.13 Wall Mount	7
2.14 Wall Bracket	8
3. Operation Instructions	9
3.1 Power-on/off	9
3.2 Mode Switching	9
3.3 Operation Instructions for Main Brush	10
3.4 Operation Instructions for Spin Mopping Brush	11
3.5 Operation Instructions for Other Brushes	12
III. Cleaning and Maintenance Instructions	13
1. Cleaning and Maintenance of Vacuum	13
1.1 Cleaning of Dust Bin	13
1.2 Charging Maintenance and Instructions	14
2. Cleaning and Maintenance Instructions for Brushes	15
2.1 Cleaning and Maintenance of Motorized Double Roller Brush	15
2.2 Cleaning and Maintenance of Soft Roller Brush	16
2.3 Cleaning and Maintenance of Spin Mopping Brush	17
2.4 Cleaning and Maintenance of Motorized Mattress Brush	18
2.5 Cleaning and Maintenance of Lighted Crevice Nozzle	18
IV. Common Problems, Solutions and Instructions	19
V. RoHS Checklist	20

I. Safety Instructions



IMPORTANT SAFETY INSTRUCTIONS

When using an electrical appliance, basic precautions should always be followed, including the following:

READ ALL INSTRUCTIONS BEFORE USING (THIS APPLIANCE). Failure to follow the warnings and instructions may result in electric shock, fire and/or serious injury.

WARNING—To reduce the risk of fire, electric shock, or injury:

1. Do not use outdoors or on wet surfaces.
2. Never use it as a toy. Close attention is necessary when used by or near children, pets, or plants.
3. Only use it as described in this manual. Only use the prepacked accessories and charger.
4. Do not use with damaged cord or plug. If the appliance is not working as it should, has been dropped, damaged, left outdoors, or dropped into water, do not use it and seek help from a service center.
5. Do not pull or carry the appliance by the power cord, use the cord as a handle, close a door on the cord, or pull the cord around sharp edges or corners. Do not run the appliance over the cord. Keep cord away from heated surfaces.
6. Do not unplug by pulling on the cord. To unplug, grasp the plug, not the cord.
7. Do not handle charger, including charger plug, and charger terminals with wet hands
8. Do not put any object into openings. Do not use with any opening blocked; keep the appliance free of dust, lint, hair, and anything that may reduce airflow.
9. Keep hair, loose clothing, fingers, and all parts of the body away from openings and moving parts.
10. Be extra careful when cleaning on stairs.
11. Do not use to pick up flammable or combustible liquids, such as gasoline, or use the machine in areas where they may be present.
12. Do not pick up anything that is burning or smoking, such as cigarettes, matches, or hot ashes.
13. Do not use without dust bin and filter.
14. To prevent unintentional starting of the machine. Ensure the switch is in the off-position before picking up or carrying the appliance. Carrying the appliance with your finger on the switch or starting/charging an appliance that has the switch on invites accidents.

15. Ensure the switch is in the off-position before making any adjustments, changing accessories, or storing the appliance. Such preventive safety measures reduce the risk of starting the appliance accidentally.
16. Recharge only with the charger provided by the manufacturer. There is a risk of fire when used with another charger.
17. Use appliances only with specifically designated battery packs. Use of any other battery packs may lead to injury and fire.
18. When the battery pack is not in use, keep it away from other metal objects, like paper clips, coins, keys, nails, screws, or others that may cause a short circuit of the battery and consequently a fire.
19. Under abusive conditions, liquid may be ejected from the battery; please avoid contact. If contact accidentally occurs, flush the contact point of your body with water. If the liquid got into the eyes, please seek medical help. Liquid ejected from the battery may cause irritation or burns.
20. Do not use a battery pack or appliance that is damaged or modified. Damaged or modified batteries may exhibit unpredictable behavior resulting in fire, explosion, or risk of injury.
21. Do not expose a battery pack or appliance to fire or excessive temperature. Exposure to fire or temperature above 130°C may cause an explosion.
22. Follow all charging instructions and do not charge the battery pack or appliance outside of the temperature range specified in the instructions. Charging improperly or at temperatures outside of the specified range may damage the battery and increase the risk of fire.
23. Product repairs should always be done by a qualified repair person using only identical replacement parts. This will ensure the safe use of the product.
24. Do not modify or attempt to repair the appliance or the battery pack in ways other than indicated in the instructions.
25. The product functions at a temperature range within 40°F~104°F.
26. Risk of injury. The brush may start unexpectedly, disconnect motorized brush before cleaning or maintenance.

SAVE THESE INSTRUCTIONS

Household use only.

“” DIRECT CURRENT SYMBOL

“” STANDBY SYMBOL

II. Product Introduction and Operation Instructions

1. Vacuum Main Body

The operation manual is a general user guideline for Puppyoo T12 series, not for a specific product. T12 series includes T12 Plus Rinse, T12 Storm Rinse, T12 Pro Rinse, etc. The brush configuration varies with each model. For the specific configuration for the model you purchase, the packing list shall prevail.

① HEPA Air Outlet

Rotate to open the air outlet frame, in which the air outlet HEPA is arranged; it is recommended that the air outlet HEPA should be cleaned every three months or so.

② Speed Switch

Slide the speed switch to adjust the suction power. There are three modes: Eco-friendly(long-time endurance mode), Automatic (intelligently sense dust amount and automatically adjust the suction when the slide knob is in the middle) and Super (Super suction mode).

③ Power Button

Press the power button to turn on the machine, and press it again to turn off the machine.

④ Display Area

Notes: there are two versions for the display area of the Puppyoo T12 series: OLED Display and LED Indicator. For the specific product configuration, the model you purchased and the packing list shall prevail.

OLED Display Version

Display contents include: operation modes, charging state, real-time power, reminders, intelligent dust sensing, dust removal reminder, cleaning reminder, dust bin installation reminder and more.

LED Indicator Version

When in operation, the LED Indicator changes color (blue signals a low amount of dust, yellow signals a medium amount of dust, red signals a large amount of dust), and the machine will automatically adjust its suction power. The indicator version also displays the battery by three grids and the charging state in real-time.

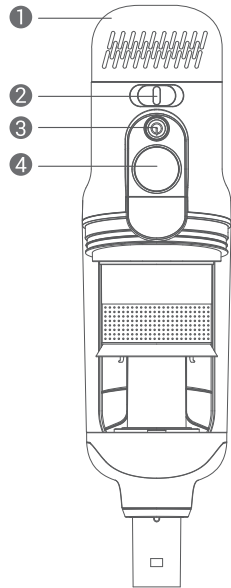

⑤ Hand Grip

The hand grip adopts an antistatic design, embedded in the grip.

⑥ Battery Cabin

The lithium-ion batteries are arranged inside the battery cabin. Do not charge, place, or use the machine close to fire or heat source (such as heating radiator, etc.), thus avoiding accidents.

⑦ Charging Jack

Please use the packaged power adapter to charge Puppyoo T12.

⑧ Dust Bin

Vertically install the dust bin. A pair of magnets is arranged inside for quick installation. (Refer 3-1 for cleaning)

⑨ Brush Connector

The brush connector connects different types of brush tools while also functioning as an air inlet. Connect it with the crevice nozzle, the motorized mattress brush, or with the metal extension tube and the motorized brush.

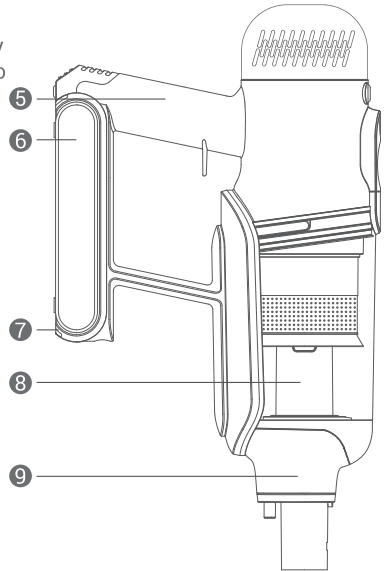

2. Accessories

The operation manual is a user guideline for Puppyoo T12 series, not for a specific product. T12 series includes many products, such as T12 Plus Rinse, T12 Storm Rinse, T12 Pro Rinse, etc. The brush configuration varies with each model. For the specific configuration for the model you purchased, the packing list shall prevail.



2.1 Metal Extension Tube

The Metal Extension Tube connects the vacuum and the brushes.

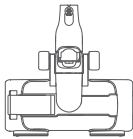

2.2 Motorized Double Roller Brush

The Motorized Double Roller Brush has a soft roller brush at the front and a carbon fiber roller brush at the rear. It is suitable for cleaning hardwood floors, floor tiles and carpets.

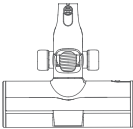

2.3 Soft Roller Brush

The Soft Roller Brush is best suited to clean hardwood floors and floor tiles.



2.4 Spin Mopping Brush

The Spin Mopping Brush is equipped with a 390ml digitally controlled water tank and two spinning mops. While in use, the mops will mop the floor at high speed, integrating vacuuming and mopping. It is suitable for thorough cleaning of hardwood floors, floor tiles and marbles. Tap water can be filled in the water tank.



Note: Please fill clean water in the water tank. Do not add any chemical cleaner and other liquids.

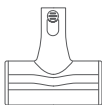

2.5 Motorized Mattress Brush

The Motorized Mattress Brush can be connected to the vacuum directly, and with the metal extension tube for extended reach. It is suitable for the cleaning surfaces of bedding, sofa, vehicle seats and other fabrics.



Note: Do not use it on fragile or delicate fabrics (such as silk) to avoid damage.



2.6 Lighted Crevice Nozzle

The Lighted Crevice Nozzle can be connected to the vacuum directly, and with the metal extension tube for extended reach. It is equipped with a bright LED lamp and is suitable for cleaning gaps, window grooves and other narrow and dark areas.

2.7 2-in-1 Square Brush

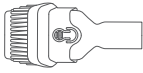

Press the middle button of the brush to retract the brush bristles.

The 2-in-1 Square Brush can be connected to the vacuum directly, and with the metal extension tube for extended reach. The Brush is suitable for cleaning tabletops, desktops and other open areas; retracted brush is suitable for cleaning of keyboards, ceiling lamps and other irregular object surfaces.

2.8 Soft Feather Brush

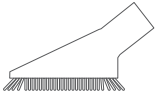

The Soft Feather Brush can be connected to the vacuum directly, and with the metal extension tube for extended reach. It is suitable for the dust cleaning of clothes, fabrics and other surfaces.

2.9 Crevice Nozzle



The Crevice Nozzle can be connected to the vacuum directly, and with the metal extension tube for extended reach. It is suitable for cleaning gaps, window grooves and other narrow areas.

2.10 Telescopic Hose

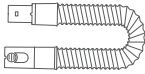

The Telescopic Hose is used for connecting the main body with the 2-in-1 square brush, the soft feather brush and the crevice nozzle for combined use so that the brushes are flexibly used for cleaning. The hose can be extended to 50cm, giving the user more flexibility to clean the corner areas.

2.11 Power Adapter

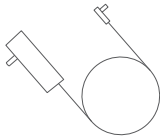

The Power Adapter is connected to the power supply and T12 main body for charging.

2.12 Charging Dock

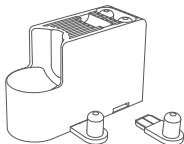

Plug board for storage

The Charging Dock is used for containing the product accessories and charging the main body. To charge, connect the power adapter to the charging dock, and then place the machine according to the body placement position.

For side containing, plug the plugboard to the base of the charging dock.

2.13 Wall Mount

The Wall Mount is used for storing and charging, even with metal extension tube and the mopping brush connected. The lower interface of the wall mount can be connected to the crevice nozzle and the soft feather brush.

To charge the vacuum, connect the power adapter to the Wall Mount, and then hang the machine according to the placement position.

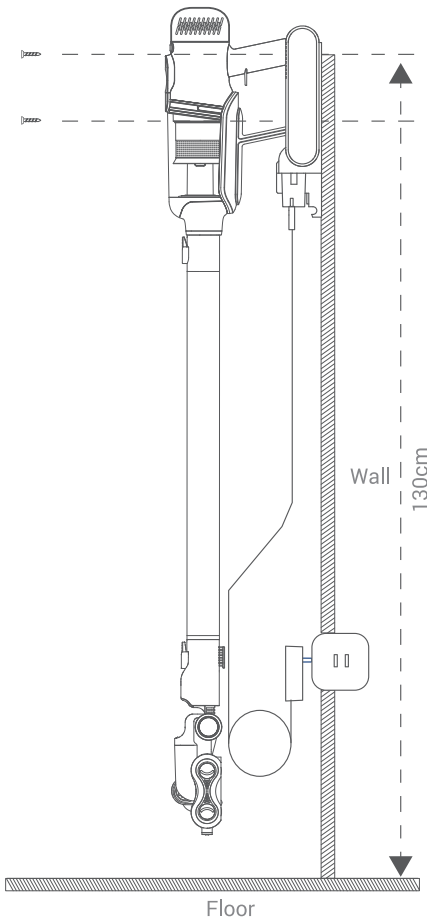

How to Install

It is necessary to punch and install the wall mount with expansion screws on the wall. Please check whether your packing list contains such configuration and screws.

1. Confirm the hole position: erect the wall mount and locate according to the upper screw hole position of the wall mount. It is suggested that it should be 130cm from the floor. Synchronously confirm the lower screw hole position of the wall mount.
2. Use a driller (user-supplied) with 5mm head, and then confirm the hole position for drilling.
3. Insert the expansion pins into the holes, place the wall mount in the corresponding position, turn the screws with a cross screwdriver from the wall mount holes, and do not screw down.
4. Horizontally adjust the wall mount and keep it vertical, and then tighten the screws to complete the installation of wall mount.
5. Clip the DC plug of the power adapter into the lower slot of the wall mount, rotate and fix it. To charge the vacuum, connect the power adapter to the power supply, and naturally place the vacuum into the wall mount from top to bottom.

 Tips: the wall mount should be installed within 150cm of the wall socket to facilitate charging.

2.14 Wall Bracket

The Wall Bracket is used for storing the product after assembling (with the metal extension tube or the mopping brush).

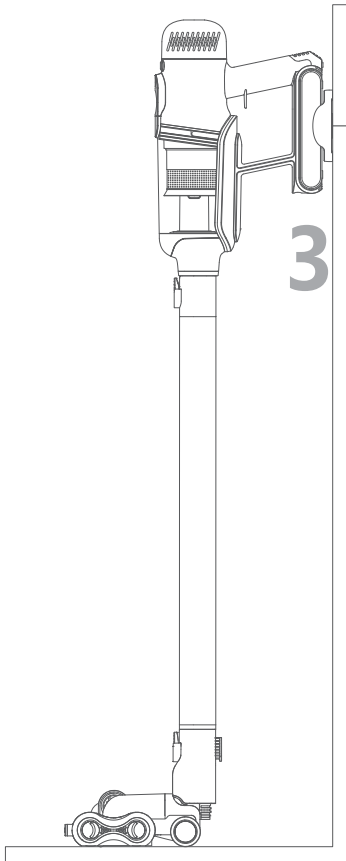

How to Install:

1. Install the wall bracket to the back of the battery cabin. (Figure 1)
2. Remove the adhesive film on the back of the bracket. (Figure 2)
3. Hold the wall bracket and the machine, keep the metal extension tube of the main body vertical to the mopping brush, place the bracket against the wall to ensure that the adhesive on the bracket directly sticks to the wall, and press tightly to complete installation. (Figure 3)

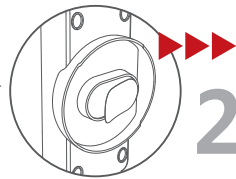
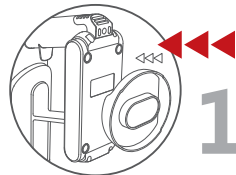

Caveats:

1. Do not stick the adhesive to the wall or object surface that it easily falls off.
2. It is suggested that the support should be stuck and fixed near the wall socket to facilitate the power adapter for plug-in charging.

3. Operation Instructions

There are two versions for Puppyoo T12 series: OLED Display and LED indicator. For the specific product and accessories configuration, the packing list shall prevail.

3.1 Power-on/off

Power-on: the power button of the product is  at the top of the vacuum. Press the button for 1 second, and the product will start working.

Power-off: press the button  for 1 second in the working state, and the product will stop working.

 Notes:

After receiving the machine, it is suggested that you should charge it first for optimal user experience;

* If the OLED display version indicates that the battery is below 20% in use, it is suggested that you should charge the machine.

* If the last grid of the battery indicator light of the LED indicator version flashes while in use, you should charge the machine.

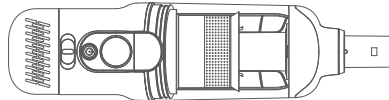

3.2 Mode Switching

There are three vacuuming modes set for the product: Super (S), Automatic (A) and Eco-friendly(E). Users can change the modes by sliding the Mode Switch at the top of the vacuum. The vacuum can be used with all brush accessories.

Mopping mode: long press the button  for 3 seconds to enter the Mopping mode, while the vacuum is attached to the spin mopping brush.

 Notes:

Slide the switch to the middle to enter Automatic (A) mode, in which the vacuum cleaning can automatically detect the amount of dust and adjust the suction power accordingly.

In the mopping mode, users should use the spin mopping brush, otherwise, the machine will not work properly.

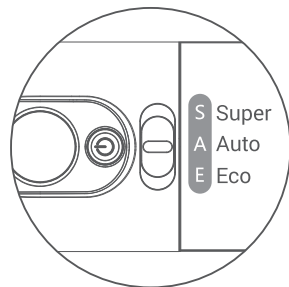



3.3 Operation Instructions for Main Brushes

1. Installation of brush

Connect the metal extension tube to the vacuum, connect one end of the brush button to the clipping part at the other end of the metal extension tube, ensure tight installation and hear a click to complete installation.

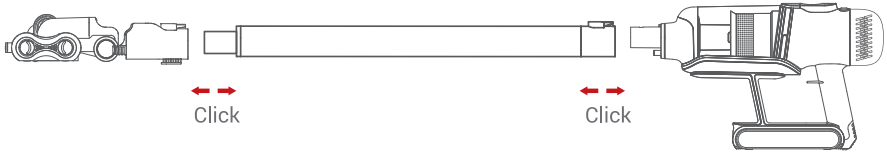
Removal of brush: hold the buckle connection of the brush, and pull out the mopping brush while pressing the release button.



2. Cleaning mode of main brush: connect the mopping brush, and press the button  for 1 second to start the cleaning mode. It is suitable for Eco-friendly(E), Automatic (A) or Super (S).

3. Cleaning mode of spin mopping brush:

①Vacuuming + mopping mode: connect the spin mopping brush, and press the button  for 1 second to start the vacuuming + mopping mode, so that the home floor cleaning can be completed in one step.

It is suitable for Eco-friendly(E), Automatic (A) or Super (S).

②Mopping mode: connect the spin mopping brush, and long press the button  for 3 seconds to start Mopping Mode. Separate dry/wet mopping can be performed on the floor or waxing can be performed on the wood floor in this mode.

Brush	Name	Best Used For
	Spin Mopping Brush	Cleaning of hardwood floors, floor tiles, marble floors and tatamis
	Motorized Double Roller Brush	Cleaning of hardwood floors, floor tiles, carpets, marble floor and tatami
	Soft Roller Brush	Cleaning of hardwood floors, floor tiles and marble floors

Precautions for Brush Use:

1. In case of brush blockage, please clean it immediately.
2. When disassembling, do not put fingers into the bottom of the mopping brush to avoid getting pinched.
3. No matter what mode the vacuum operates in, the spin mopping brush rotates at the same speed.
4. The main body, spin mopping brush and other brushes of the product do not support the water-absorbing function. Do not absorb accumulated water on the floor (such as toilet, etc.) with the product to prevent the machine from being damaged by water absorption.

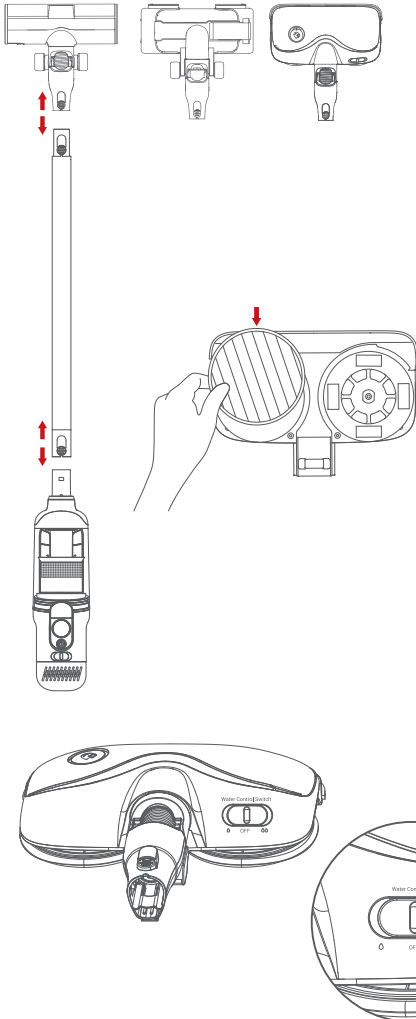

3.4 Operation Instructions for Spin Mopping Brush

1. Fill water in the water tank
Unplug the water filling plug at the top of the water tank, and fill water in the water tank with the measuring cup.

 **Caueat:** Please fill clean water in the water tank. Do not add any chemical cleaner and other liquids.

2. Install the mopping cloth

 **Caueat:** Do not install or remove the mop when the brush rotates.





3. Adjust the water volume
Push the water volume control button to high or low water volume mode to adjust the volume of water discharged to the mops.

High water volume mode: slide to ,  which is used to clean the stubborn stain.

Low water volume mode: slide to ,  which is used to clean the wooden floors or floor tiles.

Off: slide to OFF to stop discharging water, and floor mopping or waxing can be performed.

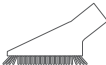
3.5 Operation Instructions for Other Brushes

Brush	Name	Best Used For
	Lighted Crevice Nozzle	cleaning of narrow space, gap, window groove, drawer, wall corner and other narrow and dark areas.
	Motorized Mite Control Brush	Surface cleaning of beddings, bed sheets, sofa, vehicle seats and other fabrics.
	2-in-1 Square Brush	Surface cleaning of desktop, table and other wide areas as well as curtain track, keyboard and other irregular objects.
	Soft Feather Brush	Dust cleaning of clothes, fabrics and other surfaces.
	Crevice Nozzle	Cleaning of gap, window groove and other narrow areas.

! Notes:

1. If the motorized mattress brush is stalled in use, please clean in time.
2. Do not clean delicate materials (such as real silk, natural silk, etc.) with the motorized mattress brush to avoid damage.
3. The product does not support the water-absorbing function. Do not absorb accumulated water on the floor (such as toilet, etc.) with the product to prevent the machine from being damaged.

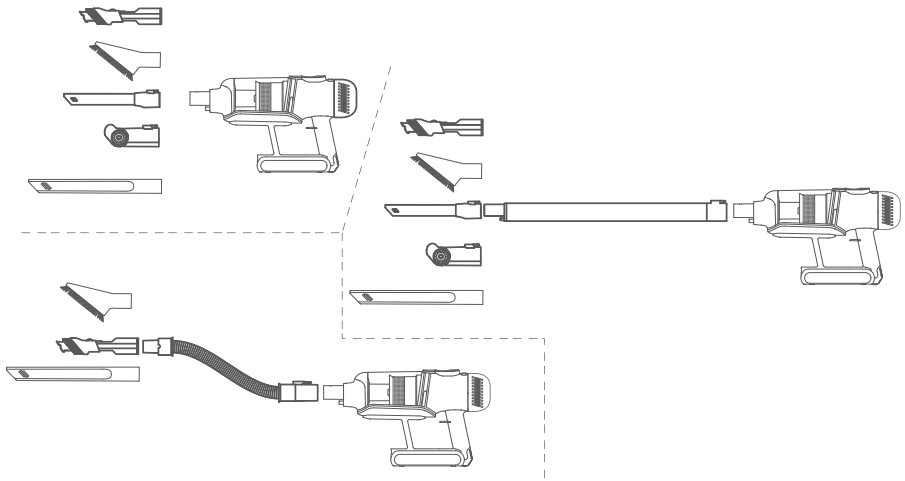

III. Cleaning and Maintenance Instructions

1. Cleaning and Maintenance of Vacuum

1.1 Cleaning of Dust Bin

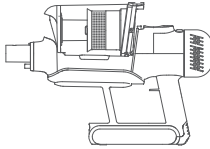

1. Hold by hand, pull up and remove the whole dust bin. A pair of magnets was preinstalled between the dust bin and the vacuum interior for quick install.

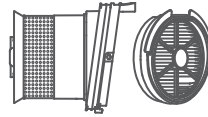

4. The filter component is composed of a cyclone filter and a HEPA air inlet filter. The HEPA air inlet filter can be removed for cleaning.

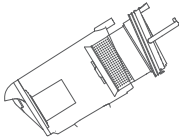

2. Erect the dust bin, pull the filter handle to remove the whole filter.

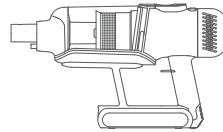

5. There is a circuit in the body. Do not wash the body, which should be cleaned with a rag instead.

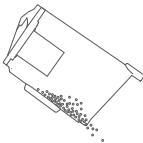

3. Pour dust out of the dust bin.

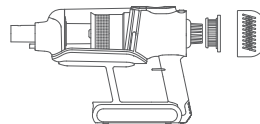

6. The HEPA air outlet frame can be removed by rotating, the HEPA air outlet is arranged inside of it, and the HEPA filter can be pulled out for cleaning. The HEPA air outlet filter should be cleaned every three months or so.

⚠ Notes:

1. To ensure the normal use of the product, please clean and maintain the air inlet filter component after use for a period of time (depending on the operating environment and frequency).
2. The dust bin and the cyclone filter are washable. After washing, be sure to dry them and keep the filter component completely dry before installation, so as not to damage the internal circuit. It is unnecessary to wash the HEPA air outlet filter. Knock it to clean without washing.
3. The product does not support the water-absorbing function. Do not absorb accumulated water on the floor (such as toilet, etc.) with the product to prevent the machine from being damaged.

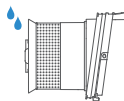

1.2 Charging Maintenance and Instructions

⚠ Tips:

1. The product is not fully charged before delivery in order to ensure transportation safety. When you receive the product, it is recommended that the product should be charged for 4 hours before normal use.
2. The product will automatically cut off the power supply for protection after being fully charged. After the full charging indicator is on for about 10 seconds, the charging indicator will be off to protect the indoor light environment, and no light pollution is generated.
3. This series of products has three charging modes. You may select your charging mode according to the configuration of the packing list for the product you purchase.

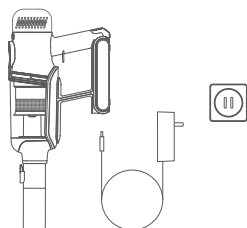

1. Plug-in Charging

Connect the power adapter to the household power supply, and insert the DC plug into the main body charging port.

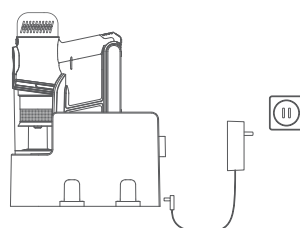

2. Charging Dock

Connect the power adapter to the household power supply, insert the DC plug into the charging dock's charging port, and place the vacuum into the slot of the charging dock.

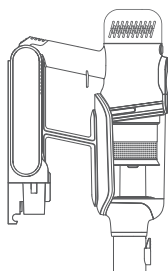

3. Wall Mount

Refer to 2.13 for the installation of the Wall Mount

Insert the DC plug of the power adapter into the charging port slot of the Wall Mount, fix it by rotating, and then connect the power adapter to the household power supply, and place the vacuum main body into the Wall Mount for charging.

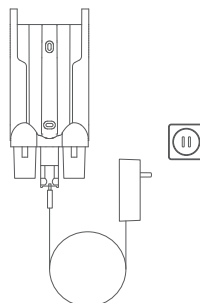

Precautions for charging

1. Unplug the power adapter of the vacuum cleaner when not in use for extended periods after being fully charged;
2. Do not install the charging dock at places directly exposed to sunlight or at high-temperature places. Please charge it at the room temperature of 5-36°C to avoid danger in the charging process;
3. The machine will power off and get charged automatically when being placed on the charging dock;
4. The temperature of vacuum main body and power adapter will normally increase when the machine is being charged;
5. The charging time and run time of the machine will be different if the machine temperature changes;
6. The machine can be used before fully charged, but the run time will be shorter;
7. Do not use with a damaged cord or plug;
8. Use only the original power adapter for charging this machine as others may damage the machine.

2. Cleaning and Maintenance Instructions for Brushes

The operation manual is a general user guideline for T12 series. T12 series includes many products, such as T12 Plus Rinse, T12 Storm Rinse, T12 Pro Rinse, etc. The brush configuration varies with each model. For the specific configuration for the model you purchased, the packing list shall prevail.

2.1 Cleaning and Maintenance of Motorized Double Roller Brush

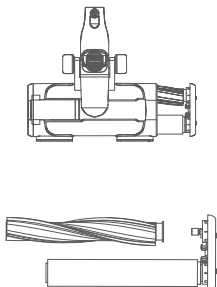

1. The motorized double roller brush can be cleaned by pulling the roller brush shaft from the side. Press two buttons on the side cover plate from outside to inside by thumb and forefinger, and then pull the roller brush body.

During installation, turn over the mopping brush, put the bottom of the mopping brush up, and then insert the dual roller brush. Press the end cover back, and the clip will automatically rebound and tighten.

2. The double roller brush consists of a soft roller and a carbon fiber roller. Both rollers can be removed from the end cover by rotating them, a slot is arranged between the roller and the end cover. Rotate the roller body to the corresponding position to install or remove the roller.

Notes:

When installing, place the soft roller at the front end of the mopping brush. It is suggested that the soft roller should not be washed as the fabric does not dry easily. The carbon fiber roller can be washed. After being dried, the carbon fiber roller should be installed together with the soft roller before use.

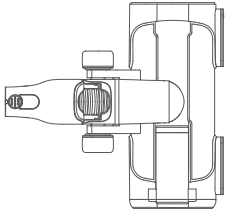

3. There is a circuit in the cavity of the motorized double roller brush. Do not wash it. Instead, wipe it gently with a rag.

2.2 Cleaning and Maintenance of Soft Roller Brush

Suggestions: clean the soft roller brush after it is used for dust collection for 4-5 times.

1. Pull the unlocking button along the arrow direction, and rotate the side cover of the brush;
2. Pull out the soft roller from the brush body (note: dust may fly when it is pulled out);
3. Remove hair, animal hair or plastic wrappers on the soft roller, and remove the dust;
4. Operate reversely, install the soft roller into the brush body again, and ensure that it is installed in place (a click will be heard when it is installed in place).
5. There is a circuit in the cavity of the soft roller brush. Do not wash it, which can be wiped gently with a rag.

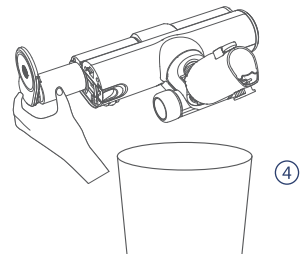
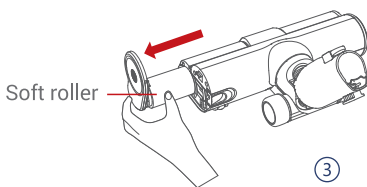
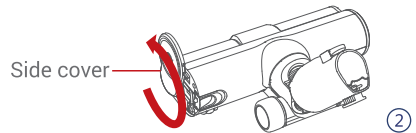
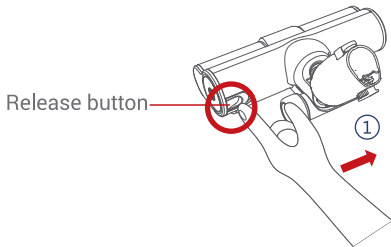

2.3 Cleaning and Maintenance of Spin Mopping Brush

1. The connection between the spin mopping brush and the cleaning cloth is in the form of magic tape. When the mop cloth is dirty, it can be removed directly from the spinning disc, wash them with water and dry them.
2. Adding water to the brush: unplug the rubber plug for the water filling hole on the upper part of the brush, and fill clean water and then insert the rubber plug.
3. The dirt at the nozzle of the spin mopping brush can be cleaned with a hairbrush, and it also can be wiped with a wet tissue when it is very dirty.

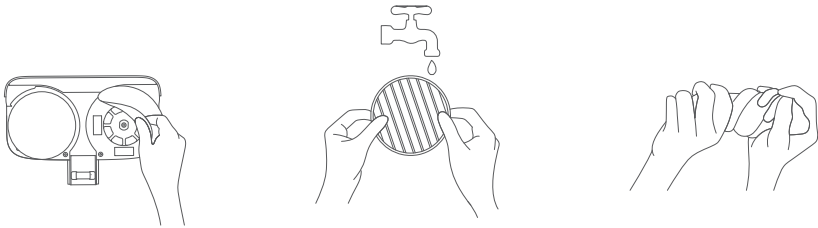

⚠ Notes:

1. There is a circuit in the cavity of the brush. Do not wash it.
2. If the product is not used for a long time, drain off the residual water in the water tank. Unplug the water filling plug, pour out all water inside, and remove the residual water by shaking left and right. Keep the filling plug unplugged to dry the water tank in the well-ventilated area.
3. The product does not support the water-absorbing function. Do not absorb accumulated water on the floor (such as toilet, etc.) with the product to prevent the circuit from being damaged.
4. After washing the mopping cloth, let it dry completely before store or put it back.

2.4 Cleaning and Maintenance of Motorized Mattress Brush

1. Pull the unlocking button along the arrow direction, and rotate the side cover of the mite control brush.
2. Pull out the roller brush from the brush body (note: part of dust will fly when it is pulled out);
3. Remove hair, animal hair or fragments wound on the roller brush, and dust off;
4. Operate reversely, install the roller brush into the brush body again, and ensure that it is installed in place (a click will be heard when it is installed in place).
5. There is a circuit in the cavity of the electric mite control brush. Do not wash it, instead, wipe it gently with a rag.

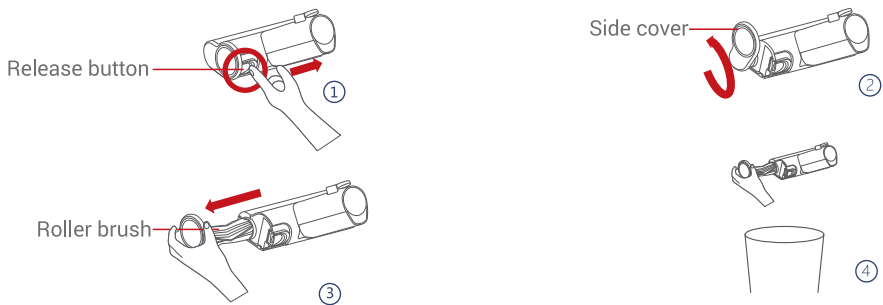

2.5 Cleaning and Maintenance of Lighted Crevice Nozzle

1. The dirt at the nozzle of the brush can be cleaned with a dry rag, and wipe with a wet tissue when it is very dirty.
2. There is a circuit at the snap joint of the brush. Do not wash.

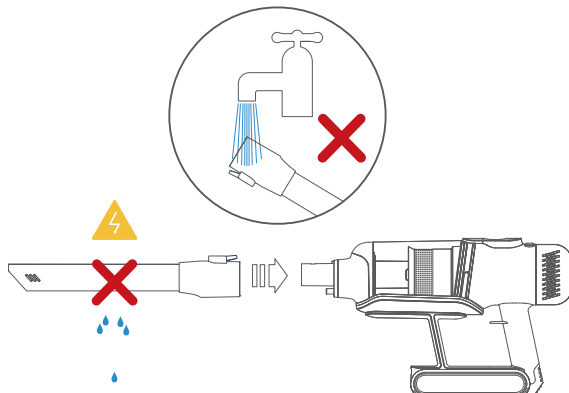

Note:

The product does not support the water-absorbing function. Do not absorb accumulated water on the floor (such as toilet, etc.) with the product to prevent the machine from being damaged.

IV. Common Problems, Solutions and Instructions



The operation manual is a general user guideline for Puppyoo T12 series, not for a specific product. T12 series includes T12 Plus Rinse, T12 Storm Rinse, T12 Pro Rinse, etc. The brush configuration varies with each model. For the specific configuration for the model you purchased, the packing list shall prevail.

Problems	Possible causes	Solutions
The vacuum cleaner fails to work	<ol style="list-style-type: none"> 1. The battery is low 2. The product nozzle is blocked 	<ol style="list-style-type: none"> 1. Charge the vacuum 2. Clean the nozzle of the product
The suction of the vacuum cleaner is weak	<ol style="list-style-type: none"> 1. The dust bin and the HEPA filter are filled with dust 2. The brush is obstructed by hair and other objects 	<ol style="list-style-type: none"> 1. Clean the dust bin and the HEPA filter 2. Clean the brush
The machine is powered off after the motor has abnormal sound	The main brush or the metal extension tube are blocked	<ol style="list-style-type: none"> 1. Clean the obstruction in the main brush or metal tube 2. Contact the after-sales department if the problem still exists
Instructions for LED Indicator Version		
The three-grid battery indicator light flashes quickly	The temperature of the charging environment is too high or too low	Move the product to the place with the ambient temperature of 5-35°C for charging
The three-grid battery indicator light is off after flashing quickly for 5 seconds	<ol style="list-style-type: none"> 1. The original power adapter is not used 2. The product is placed in the high- or low-temperature environment 	<ol style="list-style-type: none"> 1. Use the original power adapter for charging 2. Move the product to the place with the ambient temperature of 5-35°C
The three-grid battery indicator light is off after flashing quickly for 2 seconds	The mopping brush or dust bin or air inlet is blocked	Clean the mopping brush, the dust bin and the air inlet filter
Instructions for OLED Display Version		
A charging alert is shown at the bottom left corner of the display	The temperature of the charging environment is too high or low	Move the product to the place with the ambient temperature of 5-35°C for charging
A charging alert is shown at the bottom left corner of the display, and the display is black after 2 seconds	<ol style="list-style-type: none"> 1. The original power adapter is not used 2. The product is placed in the high- or low-temperature environment 	<ol style="list-style-type: none"> 1. Use the original power adapter for charging 2. Move the product to the place with the ambient temperature of 5-35°C
The display is dark	<ol style="list-style-type: none"> 1. The battery is out of power 2. The product is placed in an excessively high- or low-temperature environment 	<ol style="list-style-type: none"> 1. Use the original power adapter for charging 2. Move the product to the place with the ambient temperature of 5-35°C
The display indicates that the mopping brush is jammed	The mopping brush is blocked or seized	Clean the mopping brush
The display screen indicates that the product can be used after the dust bin is installed	The dust bin is not installed	Please install the dust bin and then start the machine

If the above problem persists, please contact the after-sales department of Puppyoo.

V. RoHS Checklist

Component Name	Hazardous and Noxious Substances or Elements					
	Lead (Pb)	Mercury (Hg)	Cadmium (Cd)	Hexavalent chromium (CrVI)	Polybrominated biphenyls (PBB)	Polybrominated diphenyl ethers (PBDE)
Plastic	○	○	○	○	○	○
Motor	○	○	○	○	○	○
Circuit board	×	○	○	○	○	○
Cable	○	○	○	○	○	○
Metal part	×	○	○	○	○	○
battery	○	○	○	○	○	○

The table is prepared according to SJ/T 11364.

○ : represents that the content of the substance in all homogeneous materials of the component is below the limit specified by GB/T 26572.

× : represents that the content of the substance at least in a homogeneous material of the component exceeds the limit specified by GB/T 26572.



The product meets RoHS environmental protection requirements, and the hazardous substances contained in part of components cannot be substituted under the current international technical conditions.

The environment-friendly use period marked on the product refers to the safety period of hazardous substances or elements in the product which cannot be leaked in the normal service conditions.



Notice:



The product has an internal lithium battery. Do not decompose the battery or pile it with the general household wastes when disposing of it, so as not to pollute the environment.



Please deliver the product to the designated recycling station or professionals for treatment.

Beijing Puppy Vacuum Cleaner Group Co., Ltd.

Address: 7-605, 6th floor, No. 1 Building, No. 8 Courtyard, Guanghua Road, Chaoyang District, Beijing, China.

TEL.: 86-10-5741 7619

Email: puppyoo@moomv.com

Zip Code: 100101

Made in China